

# DECORENTWÜRFE

*Designer - Bruno Bieri*

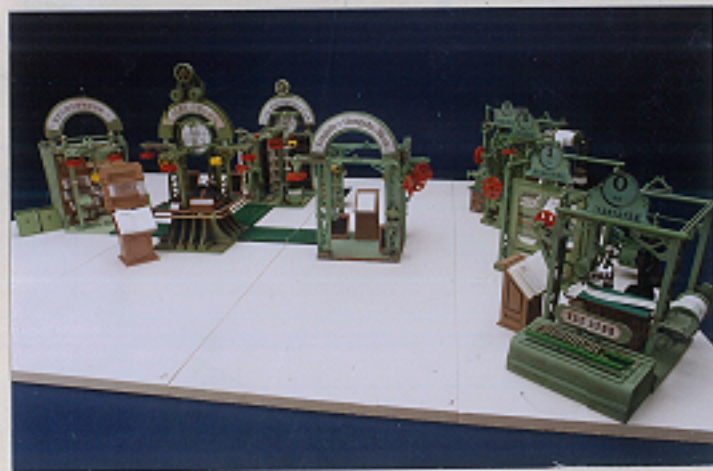

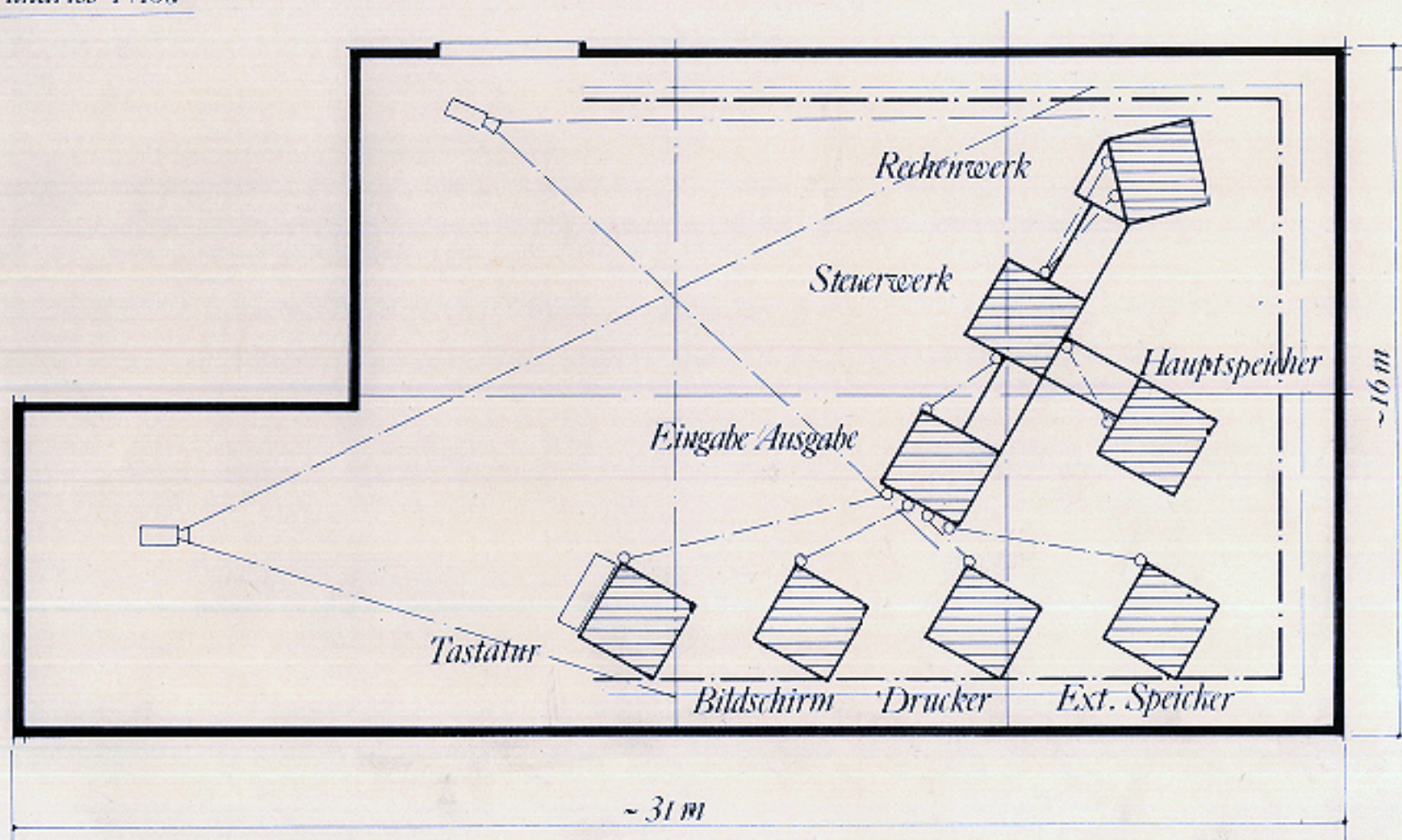

4 Bodenplatten

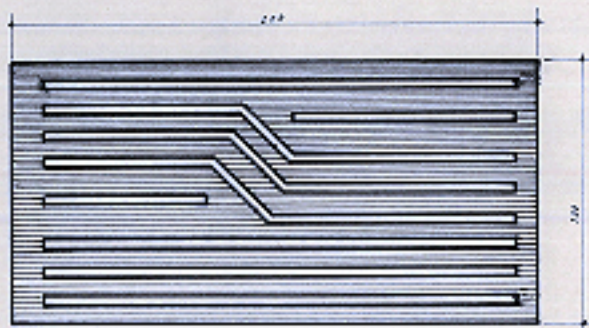

20 Säcke Rot, Grün, Blau



30 Kartonrohre



5 Büchsentelefone GELB



Kabel ROT



IBM

Ansichten Steuerwerk 1:20

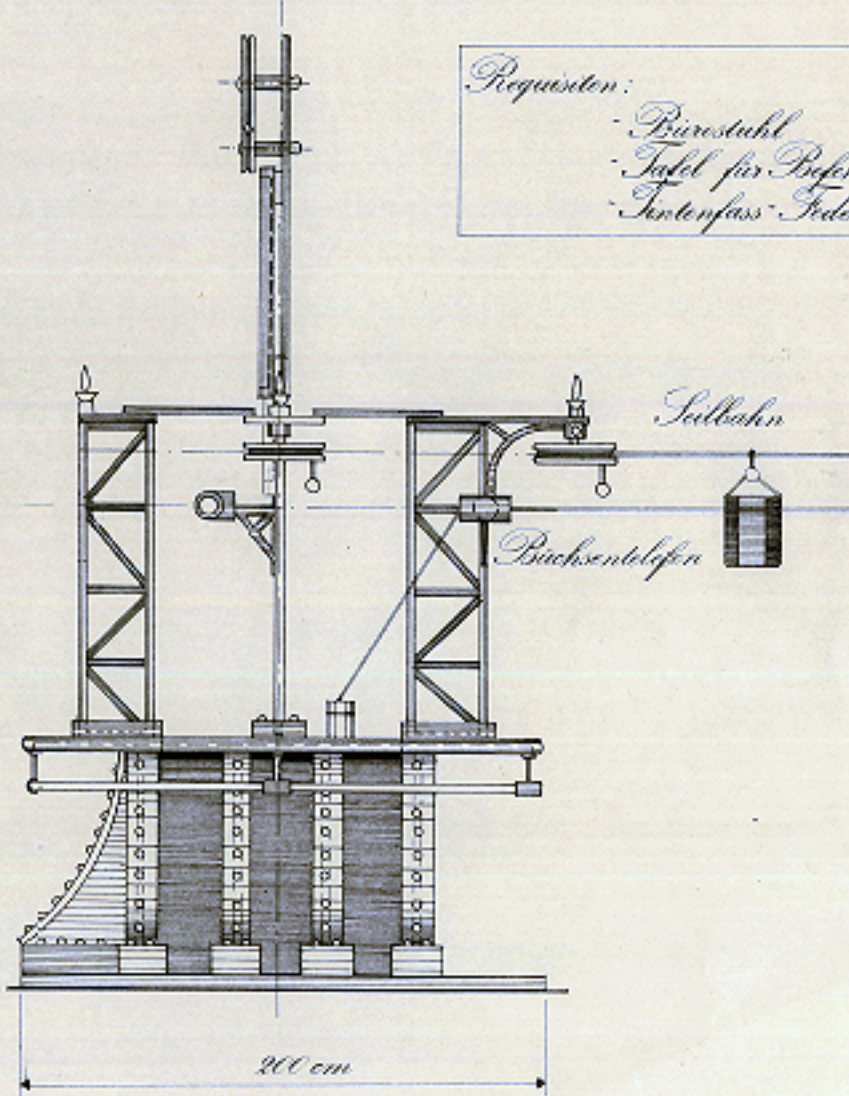
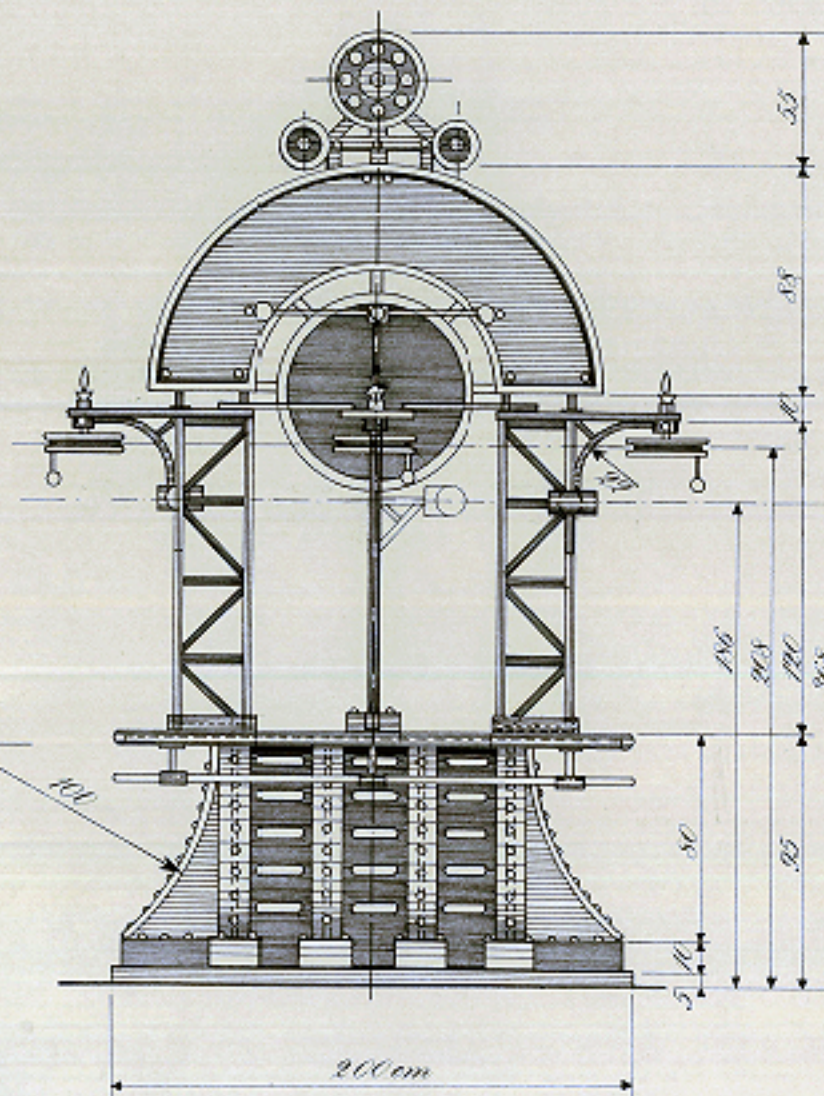

Requisiten:  
- Bürostahl  
- Tafel für Buchszähler  
- "Tintenfass" Feder



Abb. 20

### Tafel für Befehlszähler

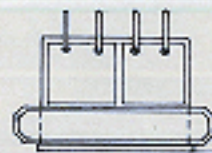
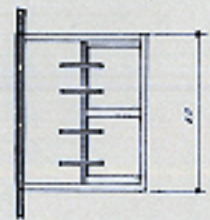
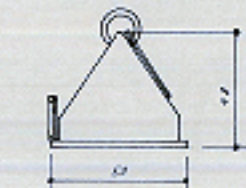

20 BLÄTTER 20 x 15  
8-9

(Tafel)  
"BEFEHLSZÄHLER"

### Buch



### Stehpult

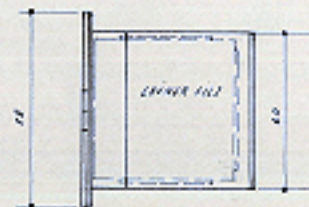
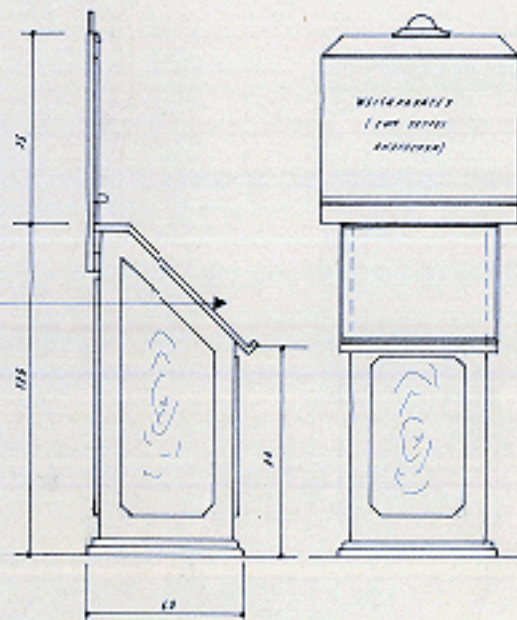

LEINERFELD - 1000

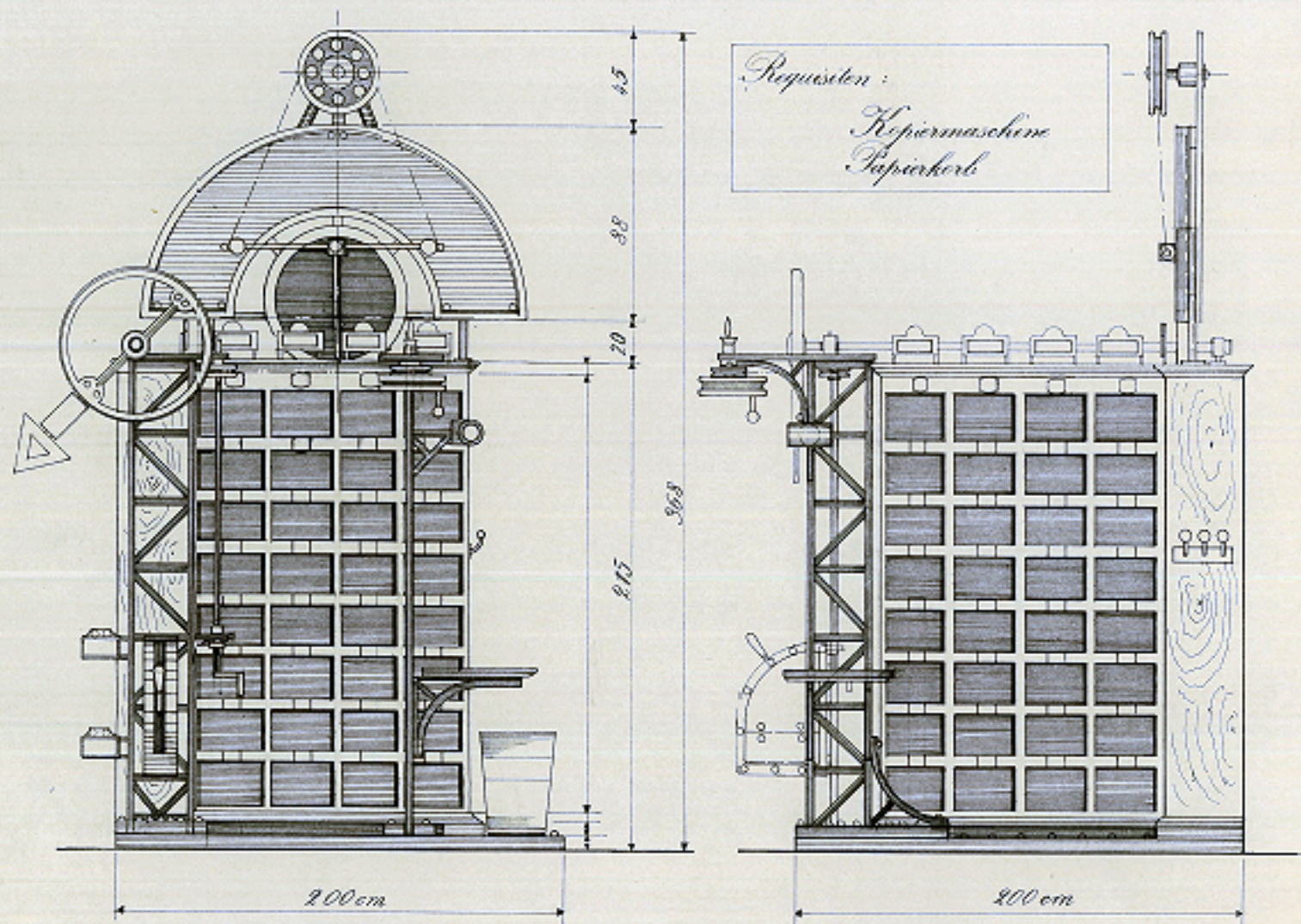

### Leiter

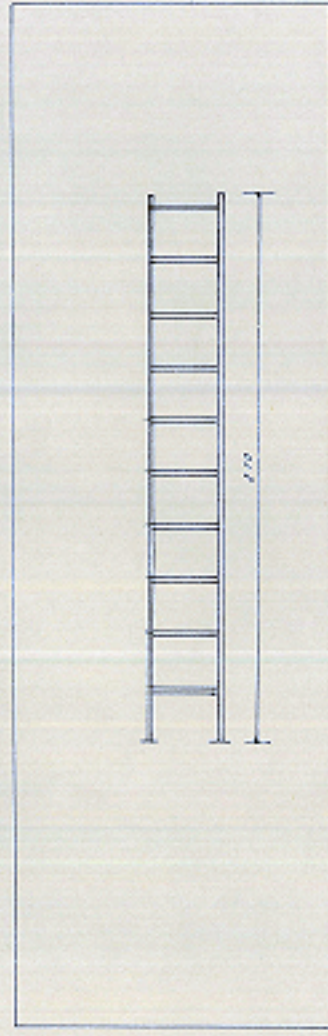

### Schilder



### Kopieranstalt

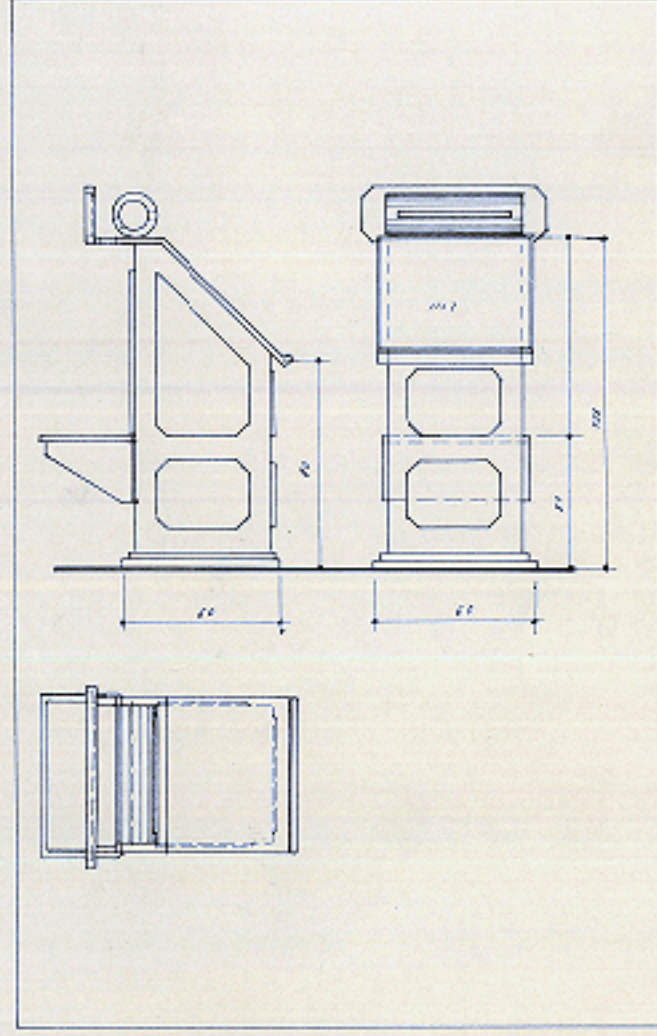

*IBM Ansichten Rechenwerk 1:20*

*Requisiten :*

*Glücksrad  
Tafel  
Kisten*

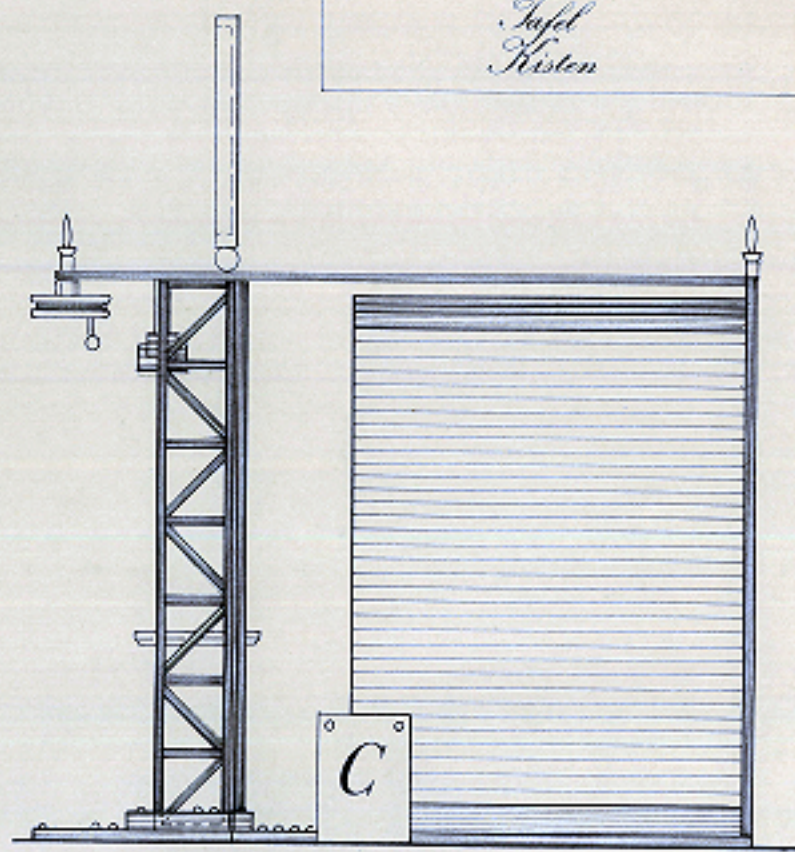
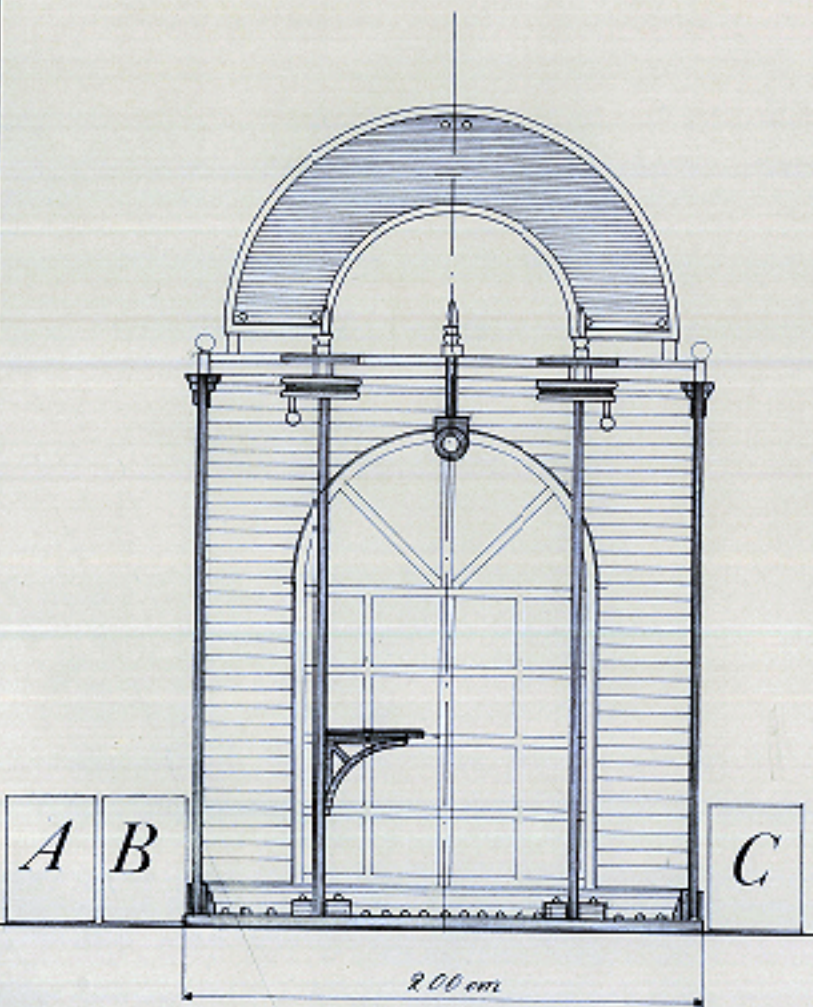



Tafel "ADD"

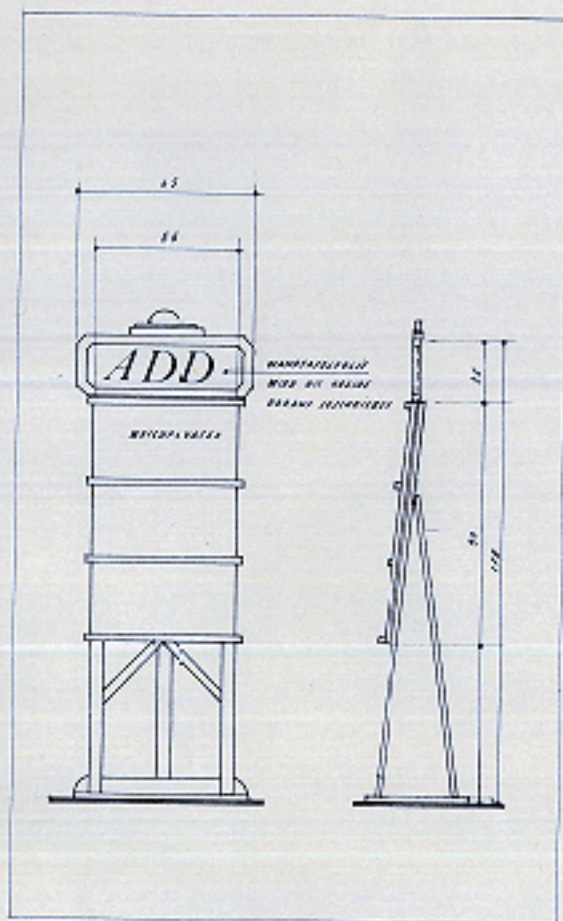

Glücksrad

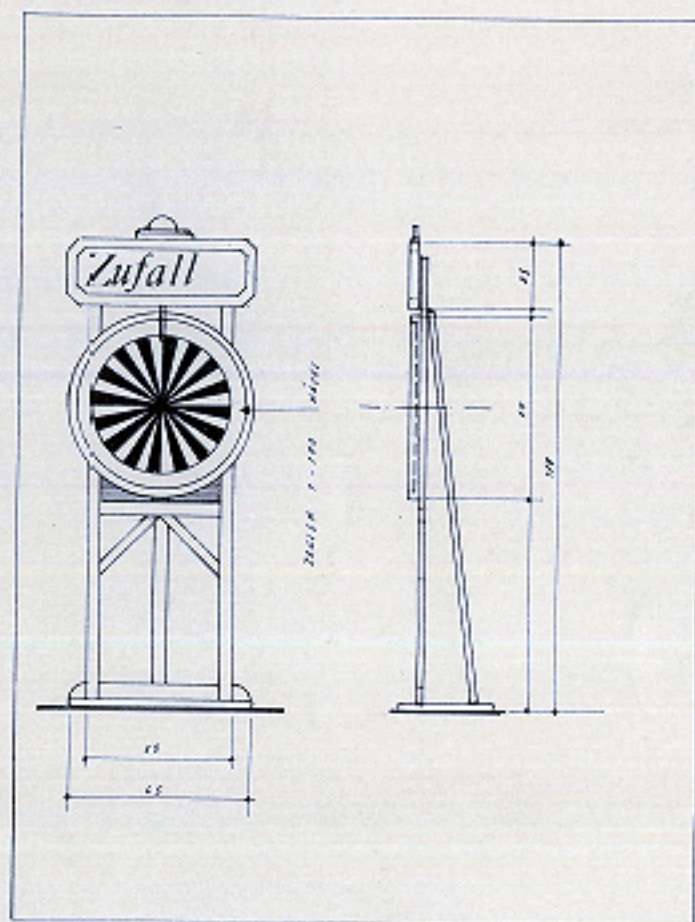

3 Kisten



*IBM* Ansichten Eingabe-/Ausgabe Werk 1:20

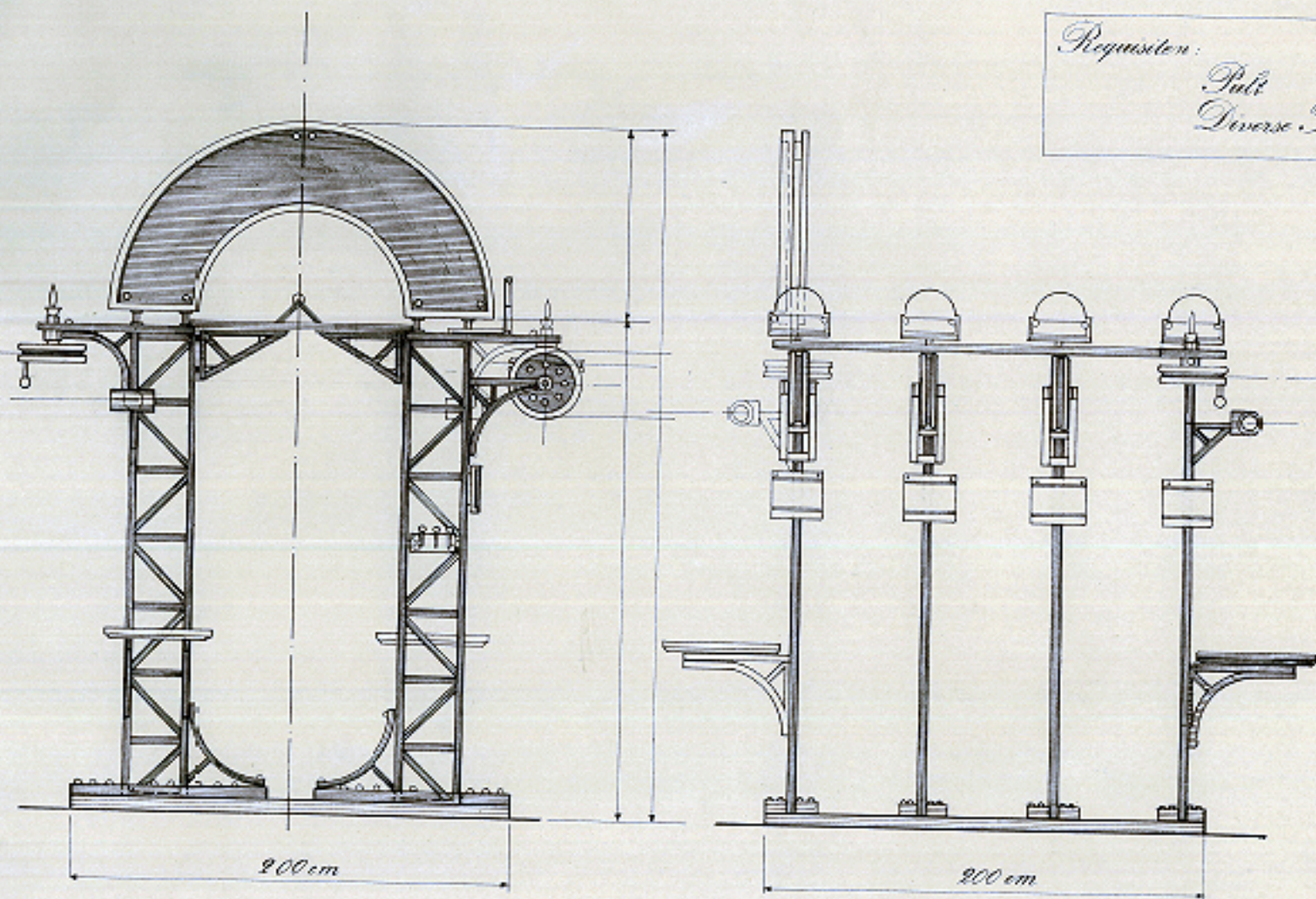

Requisiten:  
Pult  
Diverse Tafeln



2 Tafel

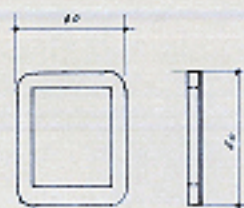

SCHWARZ  
HANDGEFERTIGT

Schilder

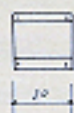

FÜR EXTERNEN SPEICHER

FÜR KLEINER

FÜR BILDTAFEL

FÜR TAFEL



AUSGABE

EINGABE

AUSGABE

AUSGABE



SCHWARZ  
/ SILBER  
/ GELB  
/ ROT  
RICHTUNG

Pult

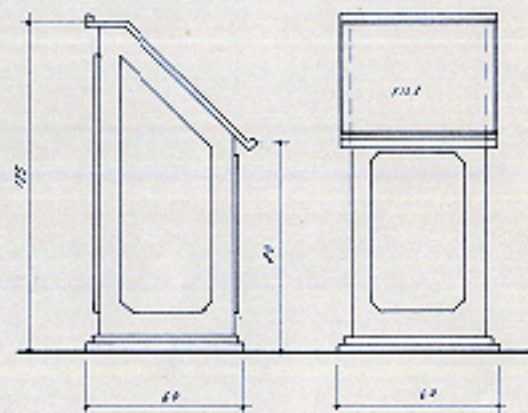

TINTENFALL - LEGER

Pult

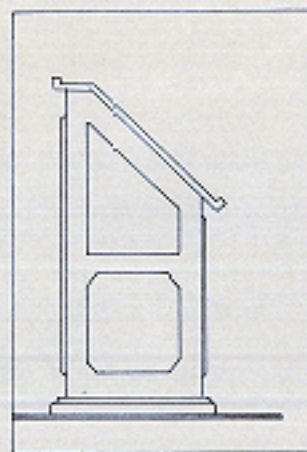

Tisch

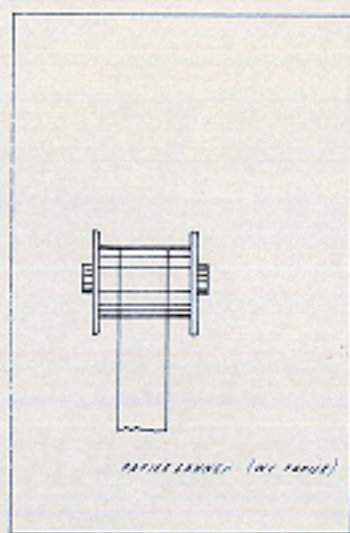
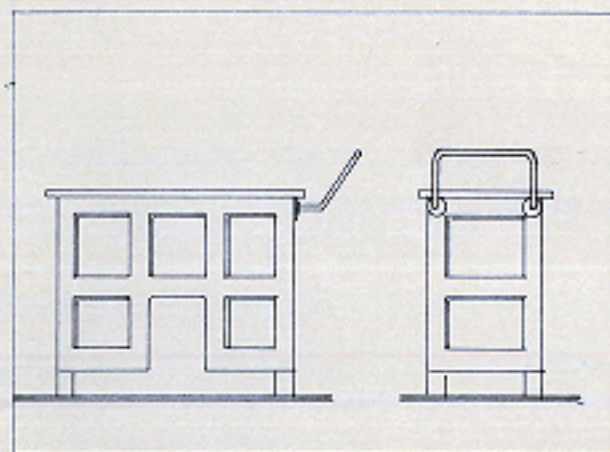

Buch

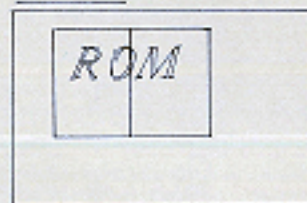

Schere

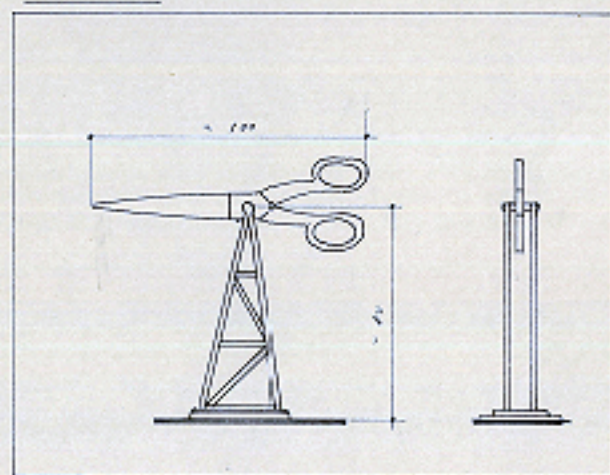

Stempel

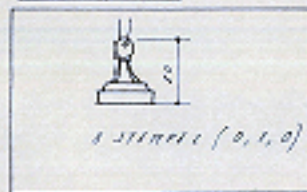

# DETAILS

Tastatur

1 : 10

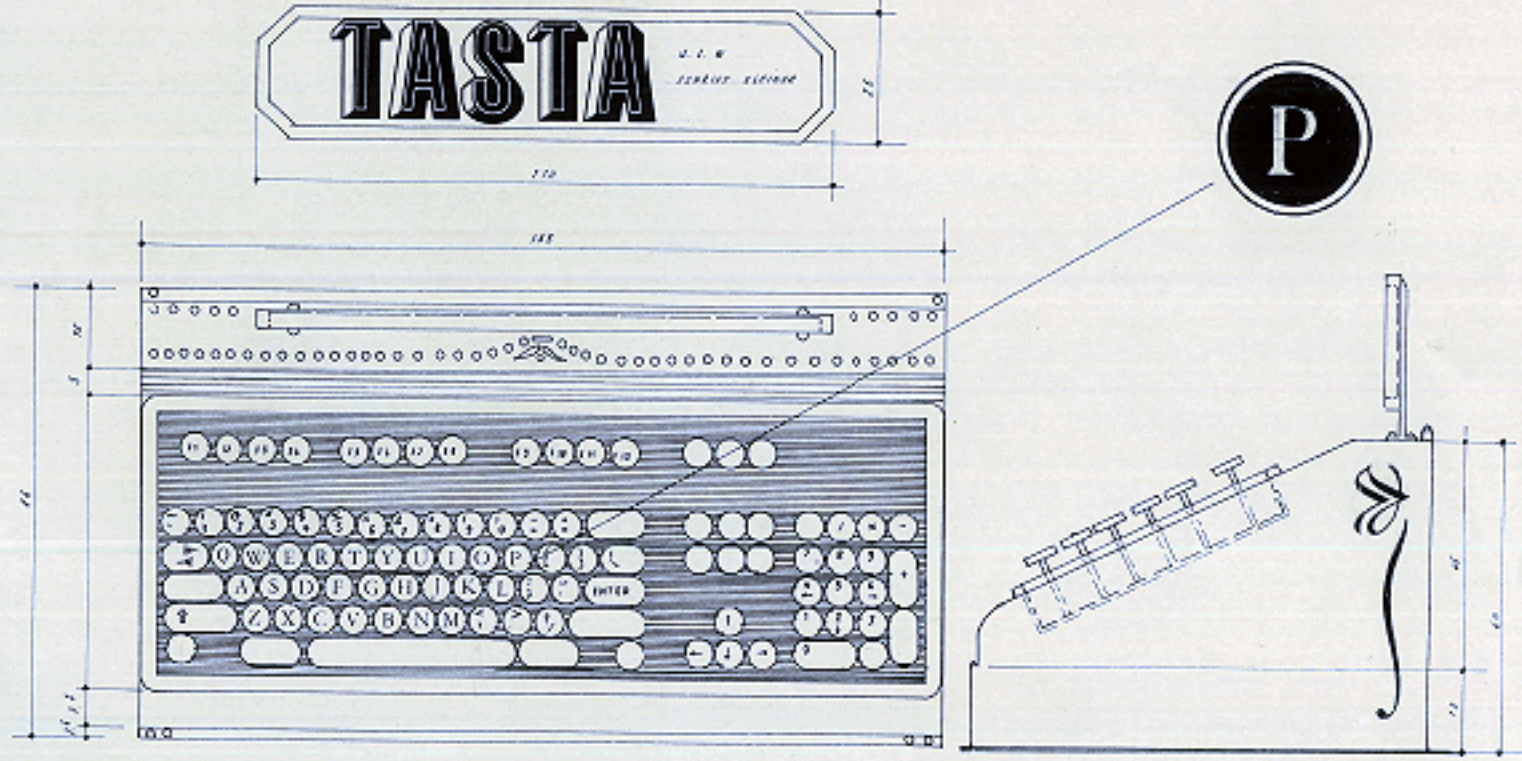

IBM

Ansichten Bildschirm 1:20

I  
01

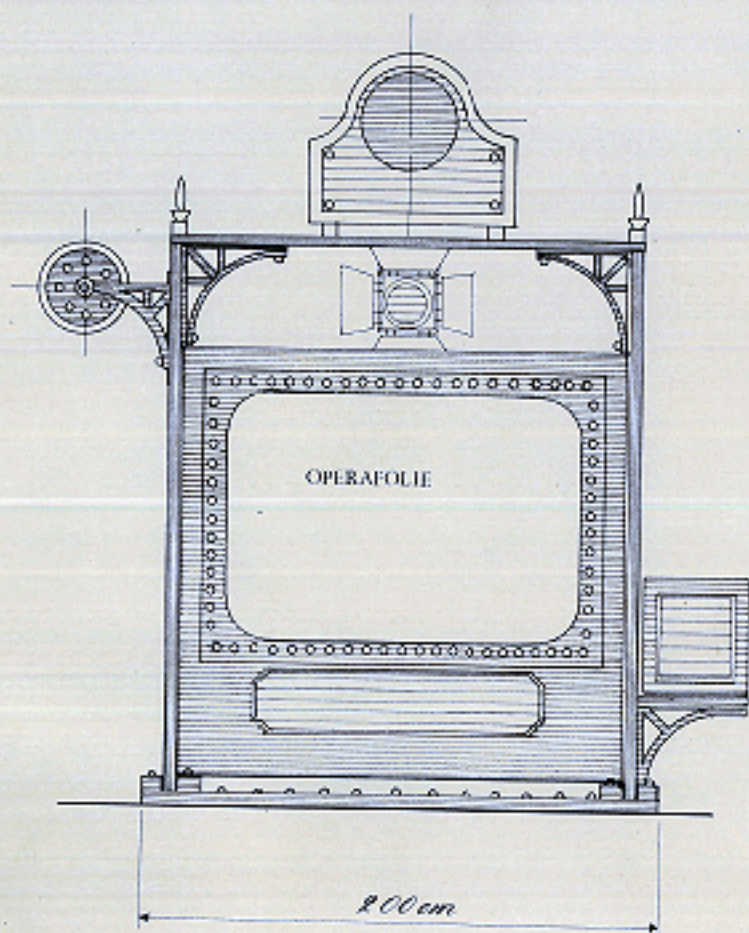

Requisiten:  
Scheinwerfer  
Tisch  
Stuhl mit R.C.M.-Buch  
Diverse Zeichen

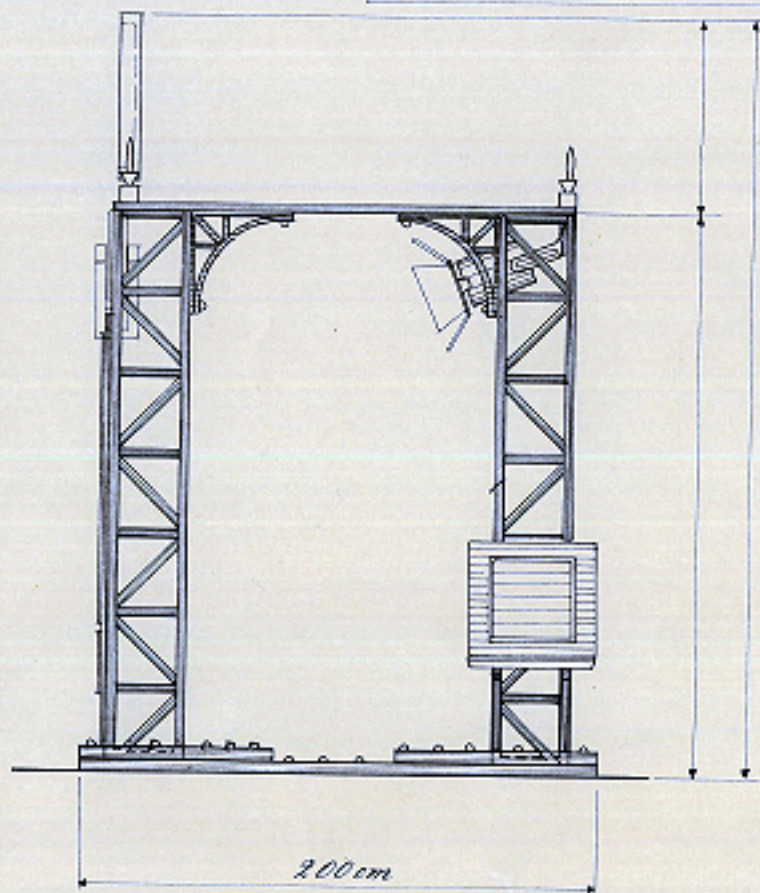

2  
10

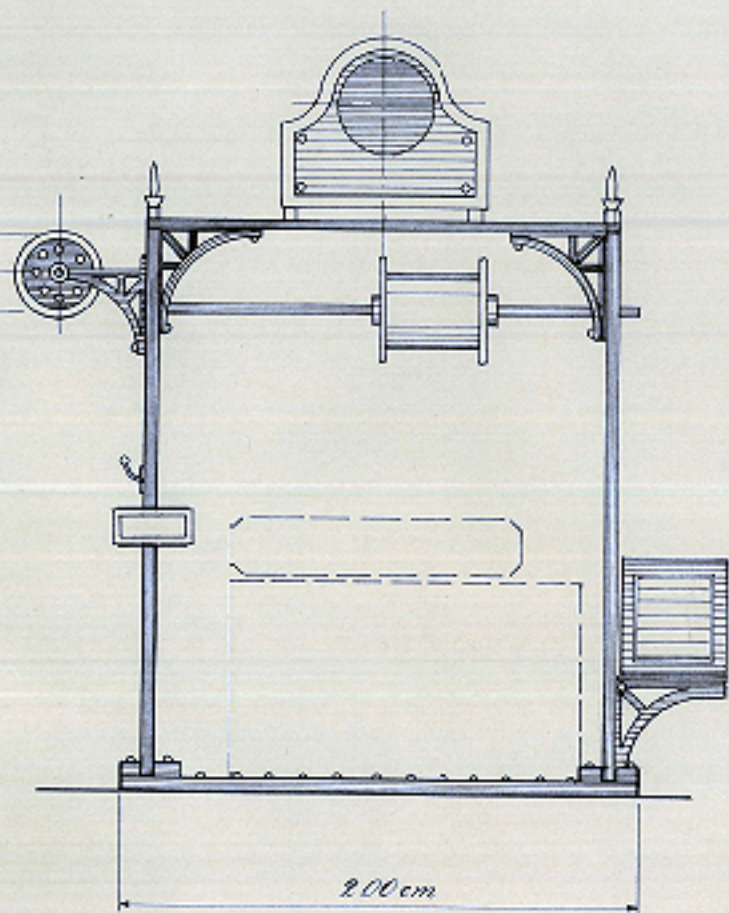

Requisiten: 2. Tische Druckelement  
Pall - Buch  
Papier-Rolle Stempel

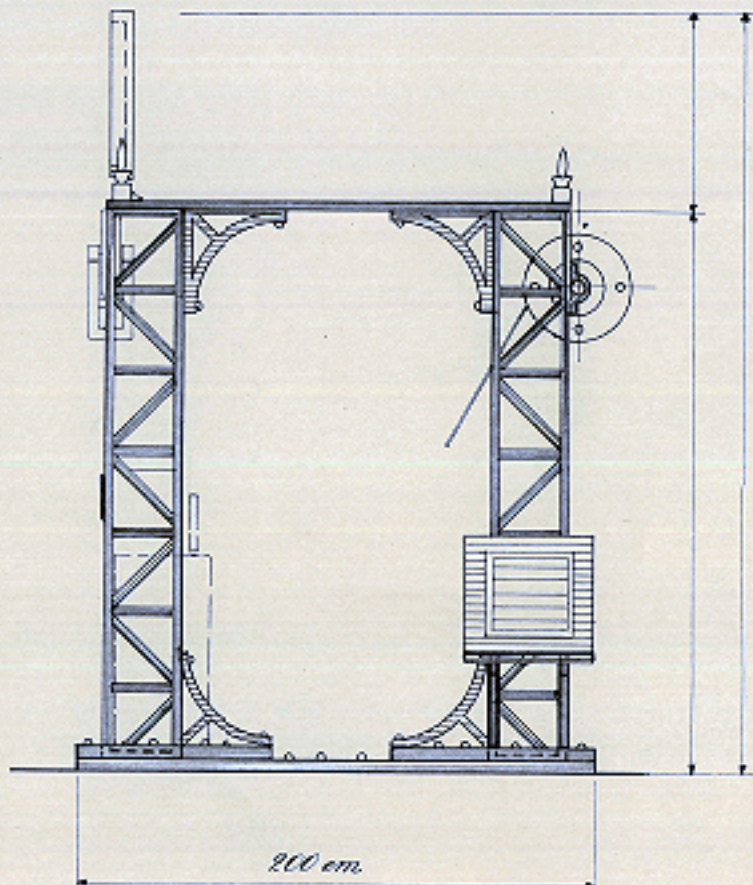

Diverses

**Pult**

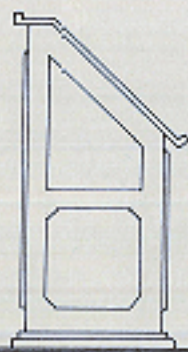

**Buch**

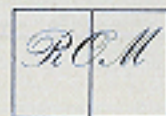

**Kiste**

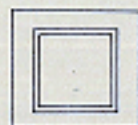

**Stempel**



1. STEMPEL (WIKKA 9.1.1)

Druckelement

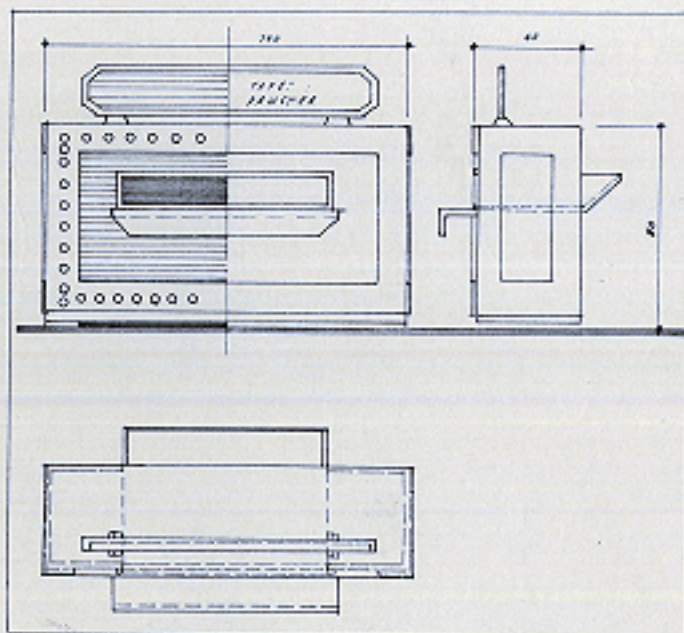

Drucktisch

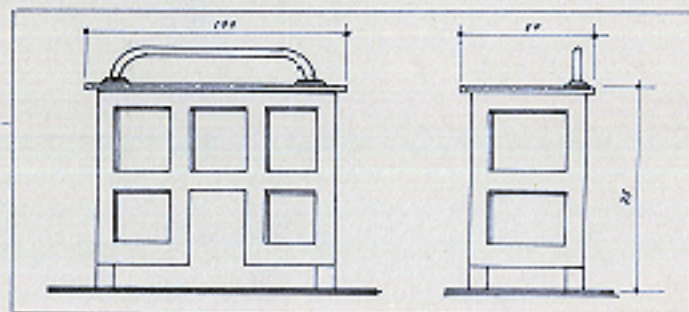

Tisch

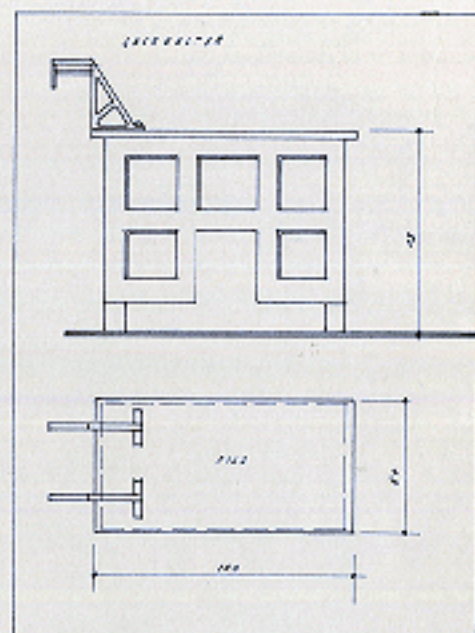

Papier

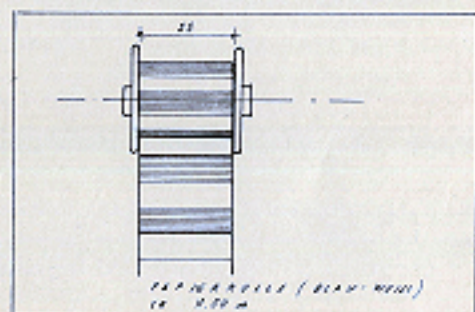



Requisiten: Pull  
Kopieranstalt  
Container  
Schilder

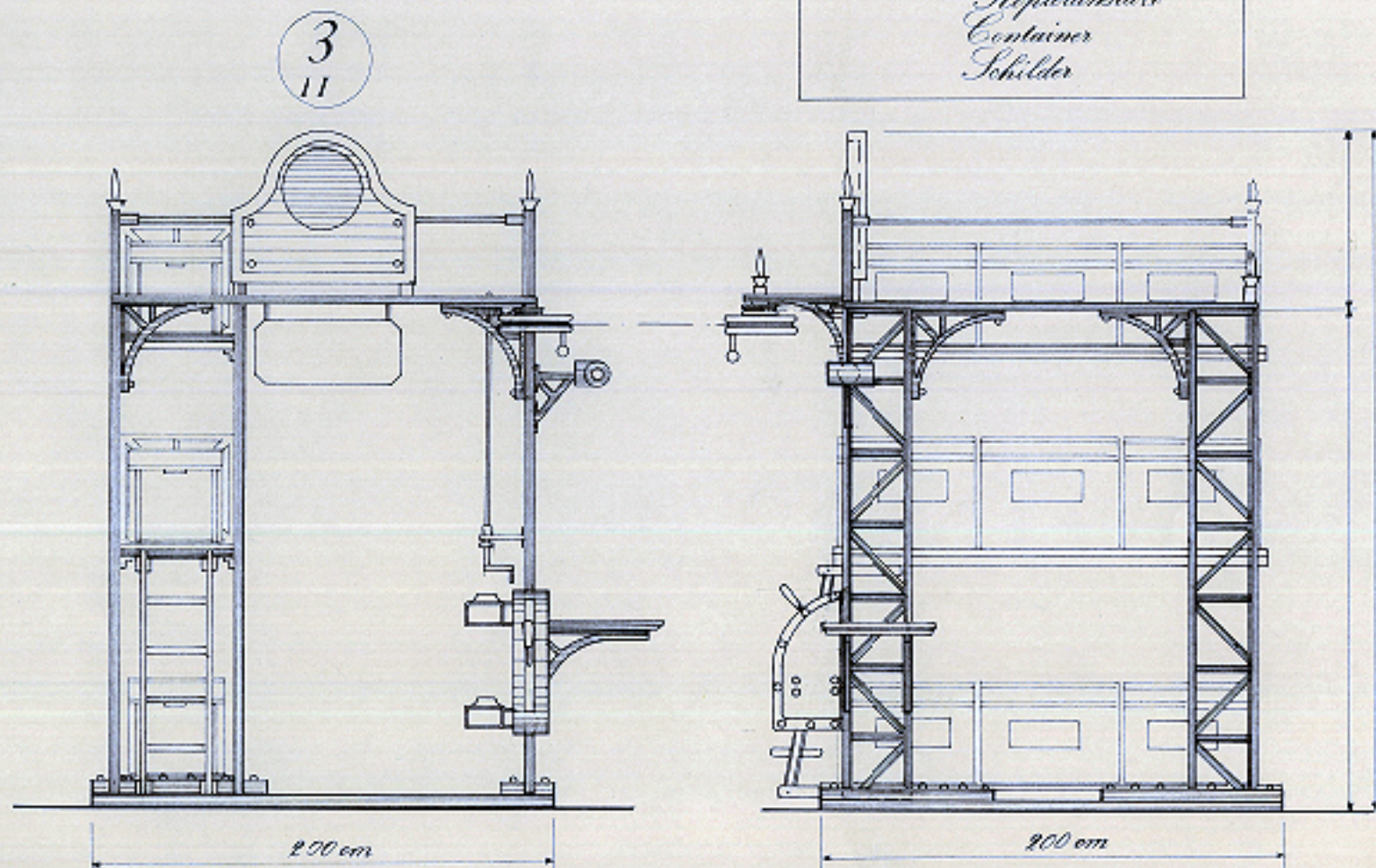

TASTATUR

0  
00

Drucker

2  
10

*Externer  
Speicher*

3  
11

BILDSCHIRM

★ ★ ★ ✧ ★ ★ ★ ★ ★ ★ ★

1  
01

STEUER

Dieser Schriftzug

Steuerwerk

Rechenwerk

Hauptspeicher

Eingabe / Ausgabe Werk